

**ALLPROOF INDUSTRIES DOMED VINYLRITE DRAIN  
80MM MEMBRANE FINISH GUTTER OUTLET**

Independent Flow Rate Test (Branz): 87 litres/minute under 25mm head of water

Specification Code	Description	Standard Finish
VR80DOME	80mm Domed drain with PVC base flange, clamp ring and dome	Cast Bronze clamp ring and dome

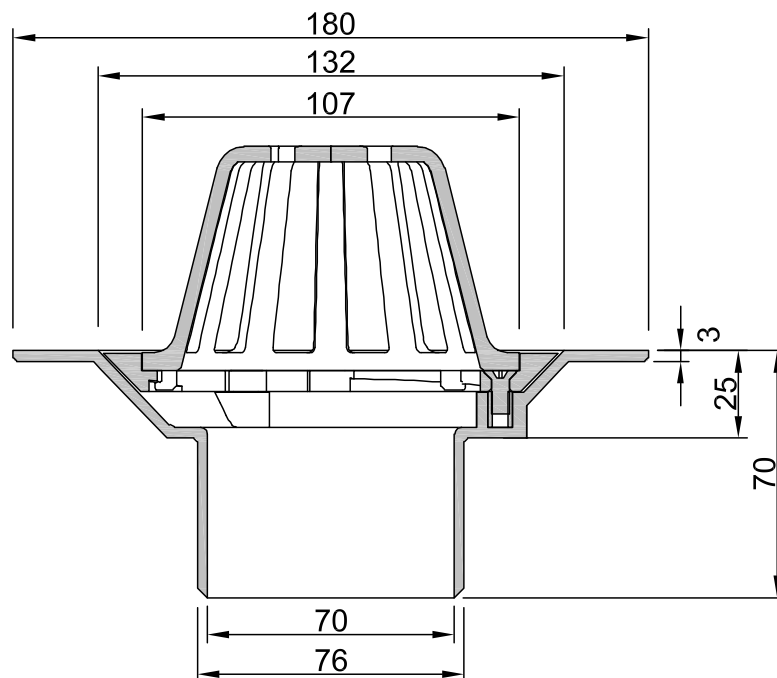
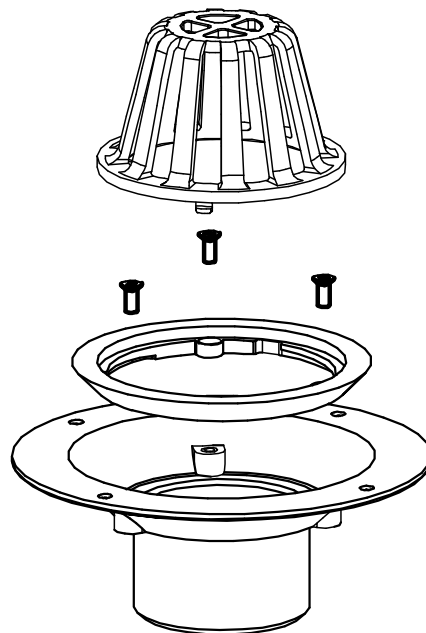

Due to Allproof Industries ongoing product development program product designs may be changed without notice.